



CROWN PAVILIONS

# Heritage Collection

The World's Finest  
Garden Rooms™

*The marque of excellence*

# The Heritage Collection

## Visit Our Frost Garden Centre Show Site

The Heritage Collection seamlessly blends traditional and contemporary elements for a garden room that offers more light, more headroom and more functional space than any other garden room in its class on the market.

The beautiful pitched roof and dormer of our pitched roof models offer an aesthetically elegant option in addition to offering superior ceiling heights.

Above all, The Heritage Collection is a Crown Pavilion, carrying the Crown Marque of Excellence which includes our well known five-star service and obsessive attention to detail.

*The marque of excellence*





“The best that money can buy...”



“After looking at numerous garden rooms and luxury wooden gazebos on the market we decided to go with Crown Pavilions as their buildings are undoubtedly the best that money can buy and the service level was exceptional. They exceeded our expectations at every stage. If you are looking for the best garden buildings on the market, then Crown Pavilions is the company to hire!”

**Lord Alan Sugar - Entrepreneur**



# Interior Showcase



Flat Roof Model



Pitched Roof Model (Lounge)



Pitched Roof Model (Store Deck)



Pitched Roof Model (Skylight)



Pitched Roof Model (Game Room)



Pitched Roof Model (Lounge)



# Key Features & Benefits

- ✧ A skylight as standard in our pitched roof models provides light in winter and ventilation in summer
- ✧ An optional veranda provides shade and a traditional feel
- ✧ An optional mezzanine store deck with fixed ladder in our pitched roof models — ideal for storage and as a hideaway
- ✧ Maintenance-free windows and doors
- ✧ A beautiful asset that enhances and adds value to your property

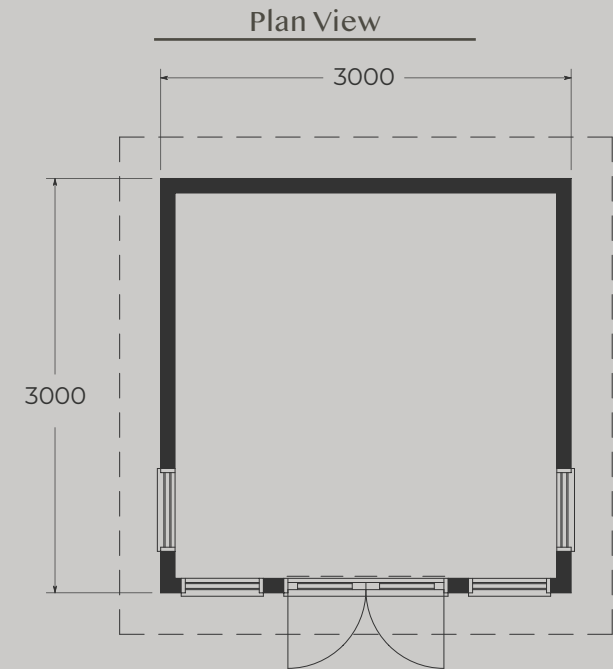
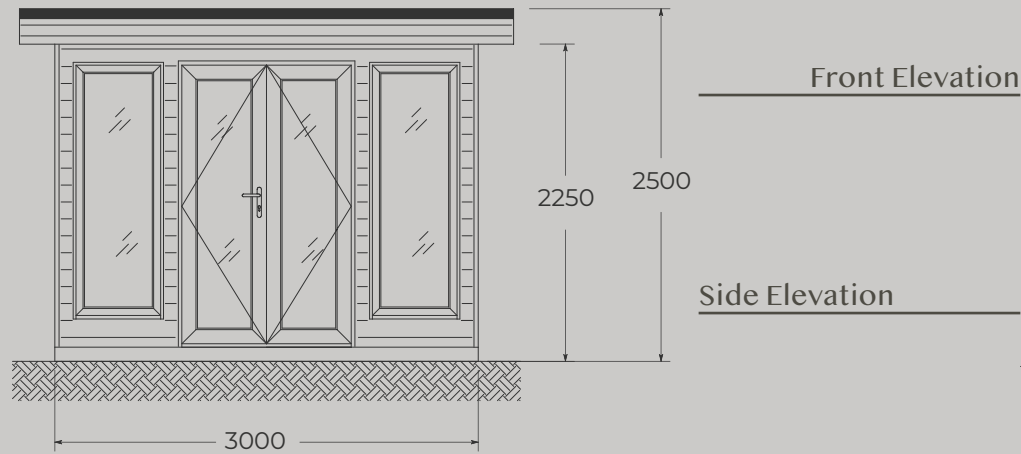

## Heritage 3.0 (Flat Roof)

The Heritage 3.0 (flat roof) at 3 meters x 3 meters is perfect as a small office or petite art studio. All our Heritage buildings are available in a range of external colours to suit your garden. At only 2.5 meters in height, it is also within permitted development guidelines which means planning permission is unlikely to be required.

### Optional Extras

Veranda (1m): **£650**

SPC flooring (Stone Plastic Composite) upgrade: **£675**

Base and mains electrical connection not included

**£19,230** incl VAT  
Installation included  
(England & Wales)

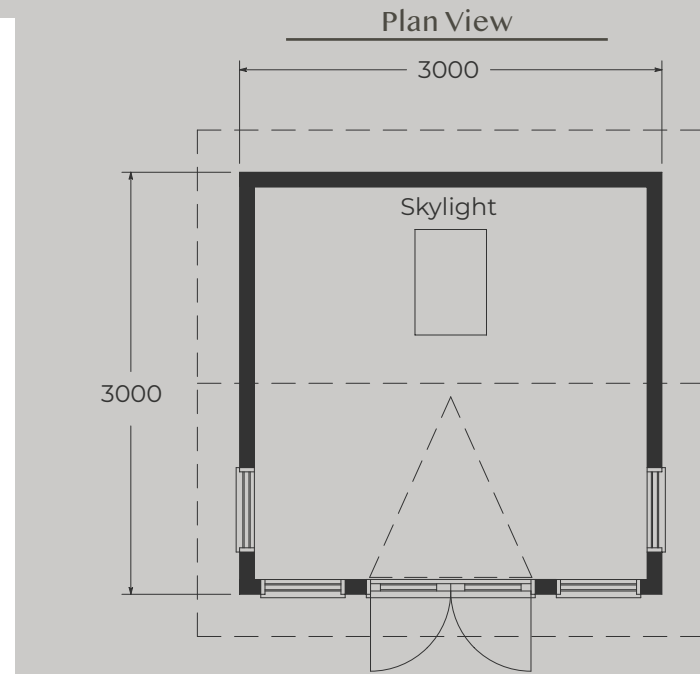
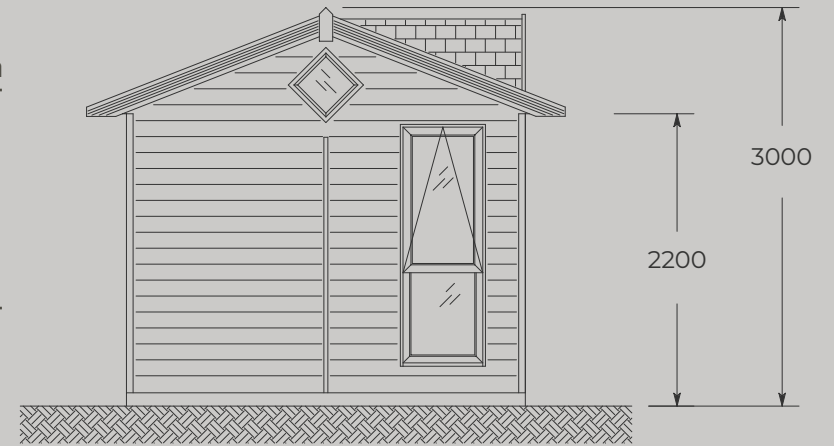
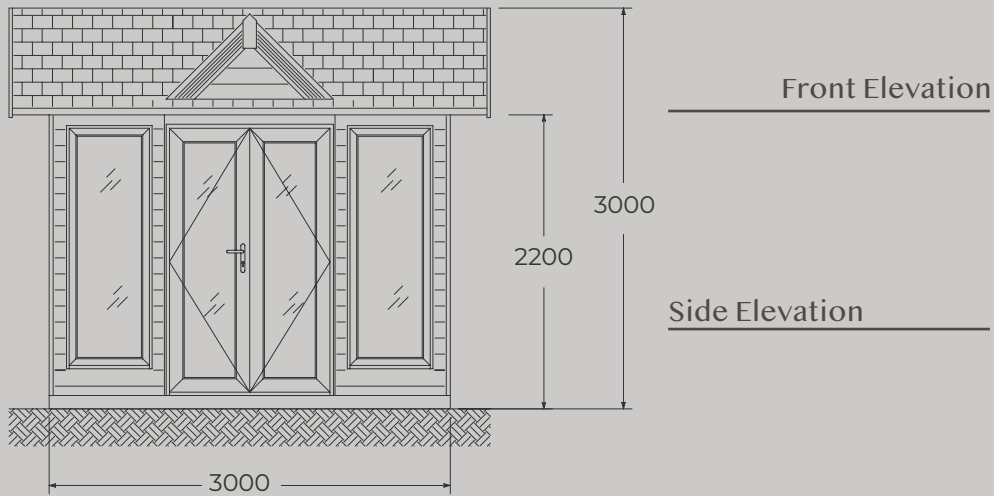

## Heritage 3.0 (Pitched Roof)

The Heritage 3.0 at 3 meters x 3 meters is perfect as a one person office or petite art studio. All our Heritage buildings are available in a range of external colours to suit your garden. Its pitched roof offers additional internal ceiling height and extra light, thanks to its integrated skylight.

### Optional Extras

Veranda (1m): **£650**

SPC flooring (Stone Plastic Composite) upgrade: **£675**

Base and mains electrical connection not included

**£23,980** incl VAT  
Installation included  
(England & Wales)

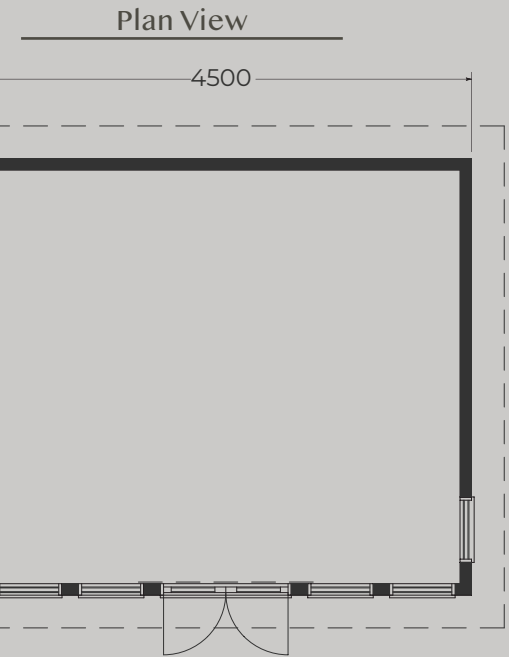
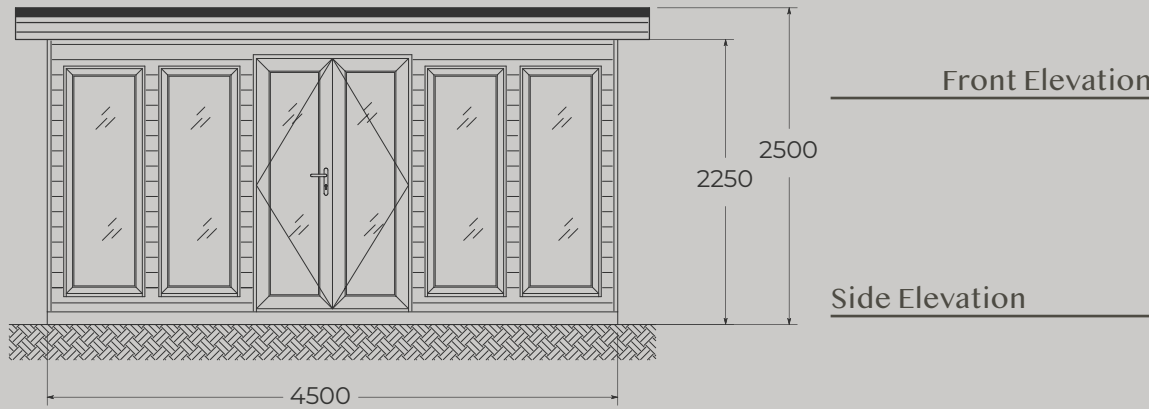

## Heritage 4.5 (Flat Roof)

The Heritage 4.5 (flat roof) at 4.5 meters x 4 meters is a very adaptable size, perfect for a larger office, with the flexibility for additional storage or a dedicated lounging area. All our Heritage buildings are available in a range of external colours to suit your garden. The size is also ideal as a games room or art studio. At only 2.5 meters in height, it is also within permitted development guidelines, so planning permission is unlikely to be required.

### Optional Extras

Veranda (1m): **£800**

SPC flooring (Stone Plastic Composite) upgrade: **£1,350**

Base and mains electrical connection not included

**£26,380** incl VAT  
Installation included  
(England & Wales)



Front Elevation

Side Elevation

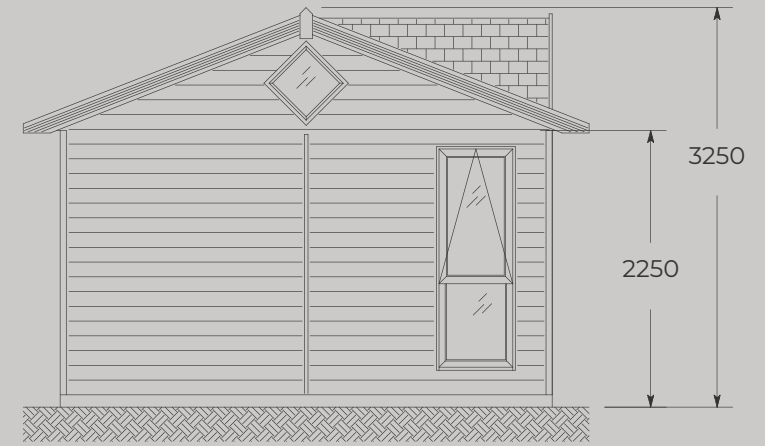

Plan View

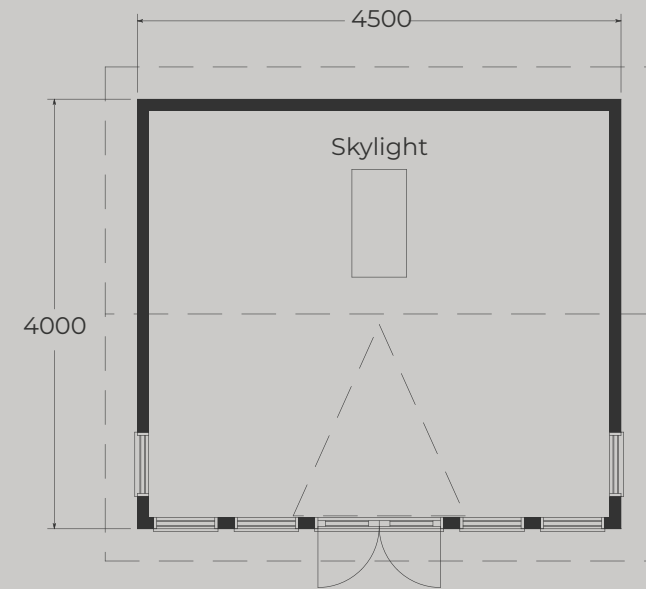

## Heritage 4.5 (Pitched Roof)

The Heritage 4.5 at 4.5 meters x 4 meters is a very adaptable size, perfect for a larger office, with the flexibility for additional storage or a dedicated lounging area. Available in a range of external colours to suit your garden. The size is also ideal as a games room or art studio. Its pitched roof offers additional internal ceiling height and extra light, thanks to its integrated skylight.

### Optional Extras

Veranda (1m): **£800**

SPC flooring (Stone Plastic Composite) upgrade: **£1,350**

Cedar tile roof upgrade: **£4,140**

Base and mains electrical connection not included

**£37,860** incl VAT  
Installation included  
(England & Wales)



Front Elevation

Side Elevation



Plan View

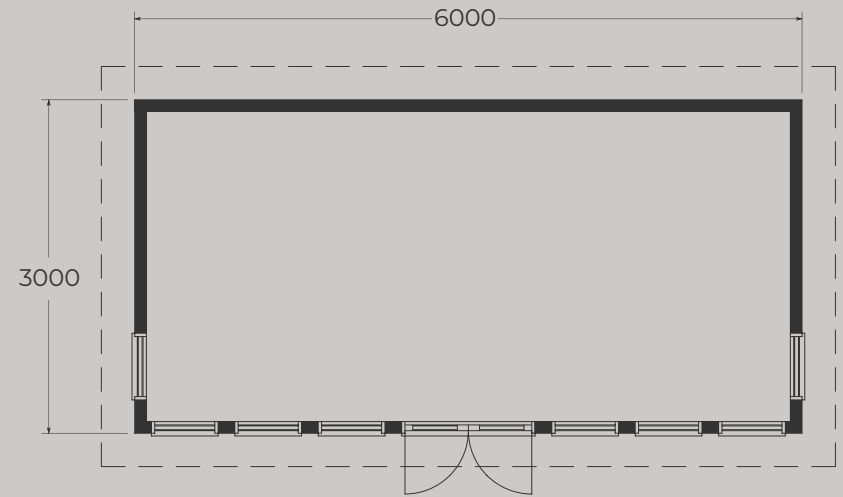

## Heritage 6.0M (Flat Roof)

The Heritage 6.0M (flat roof) at 6 meters x 3 meters is a great space for an office with room for storage and a lounging area. All our Heritage buildings are available in a range of external colours to suit your garden. Equally this model can be used as a studio, annexe, teenage den or even a cinema room. At only 2.5 meters in height, it is also within permitted development guidelines, so planning permission is unlikely to be required.

### Optional Extras

Veranda (1m): **£1,100**

SPC flooring (Stone Plastic Composite) upgrade: **£1,350**

Base and mains electrical connection not included

**£27,200** incl VAT  
Installation included  
(England & Wales)

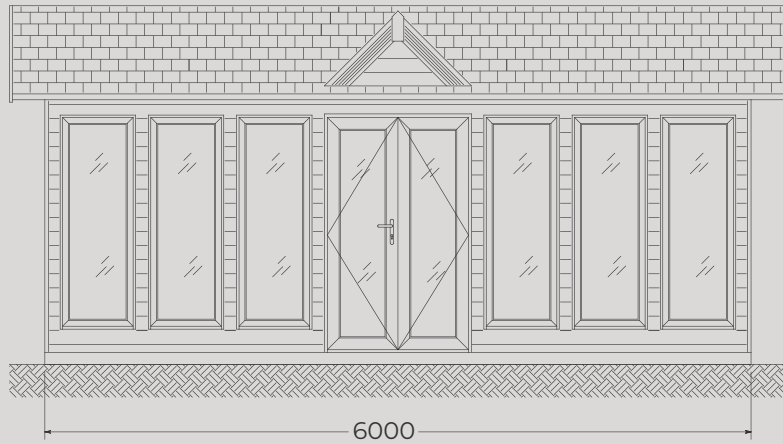

Front Elevation

Side Elevation



Plan View

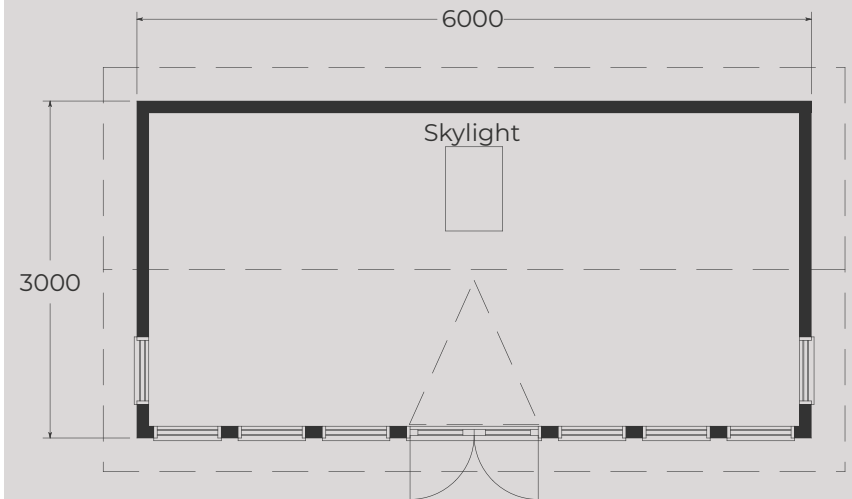

## Heritage 6.0M (Pitched Roof)

The Heritage 6.0M at 6 meters x 3 meters is a great space for an office with room for storage and a lounging area. All our Heritage buildings are available in a range of external colours to suit your garden. Equally this model can be used as a studio, annexe, teenage den or even a cinema room. Take advantage of the mezzanine store deck which is unique to the Heritage 6.0 models. Its pitched roof offers additional internal ceiling height and extra light, thanks to its integrated skylight.

### Optional Extras

Mezzanine store deck **£800**

Veranda (1m): **£1,100**

SPC flooring (Stone Plastic Composite) upgrade: **£1,350**

Cedar tile roof upgrade: **£4,140**

Base and mains electrical connection not included

**£38,400** incl VAT  
Installation included  
(England & Wales)

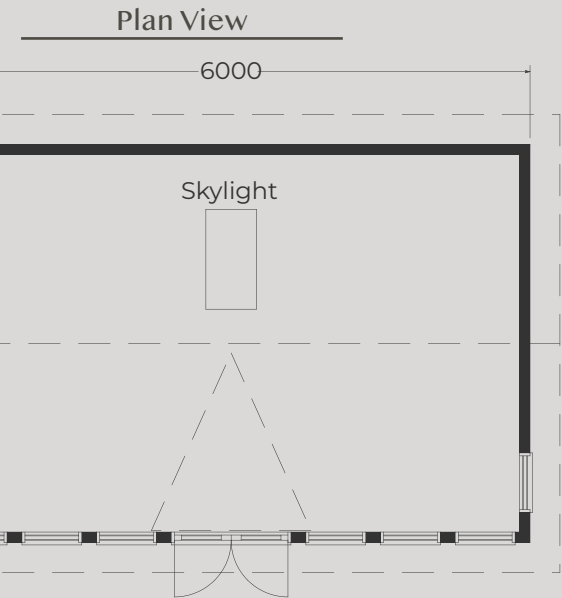
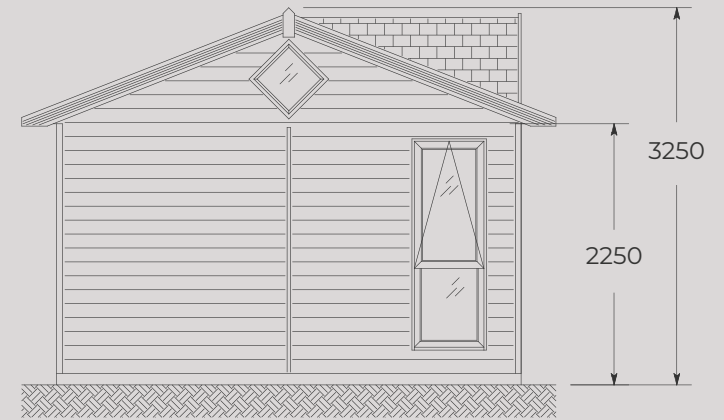
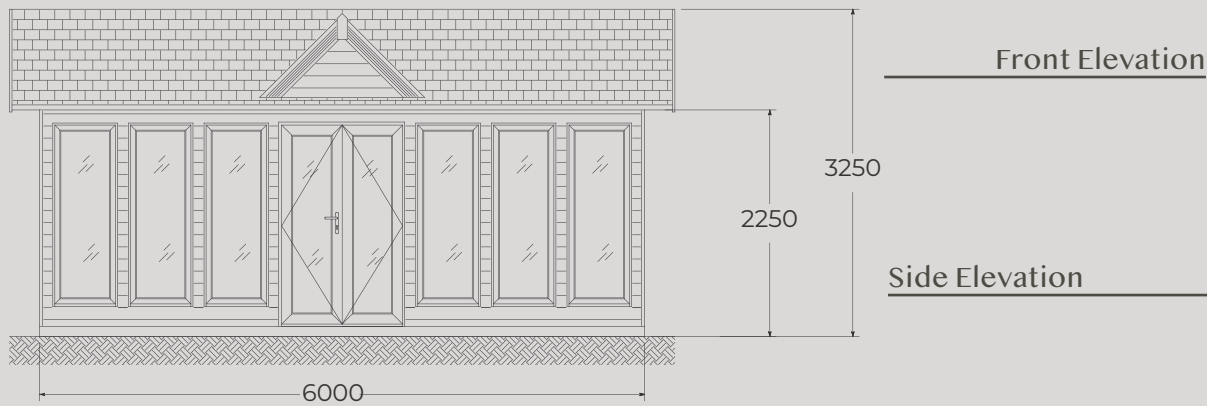

## Heritage 6.0L (Pitched Roof)

The Heritage 6.0L at 6 meters x 4 meters is one of our most popular sizes for a garden room, thanks to the flexibility this size offers. All our Heritage buildings are available in a range of external colours to suit your garden. From garden office to studio and much more. The mezzanine store deck is a great upgrade for this model, providing additional storage. Its pitched roof offers additional internal ceiling height and extra light, thanks to its integrated skylight.

### Optional Extras

Mezzanine store deck: **£800**

Veranda (1m): **£1,100**

SPC flooring (Stone Plastic Composite) upgrade: **£1,800**

Cedar tile roof upgrade: **£5,520**

Base and mains electrical connection not included

**£40,910** incl VAT  
Installation included  
(England & Wales)

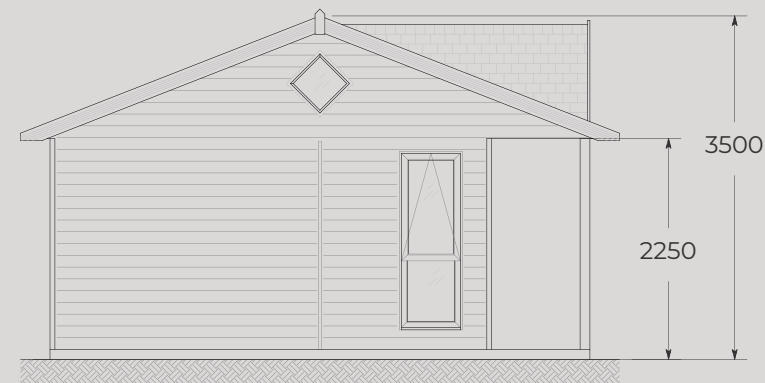
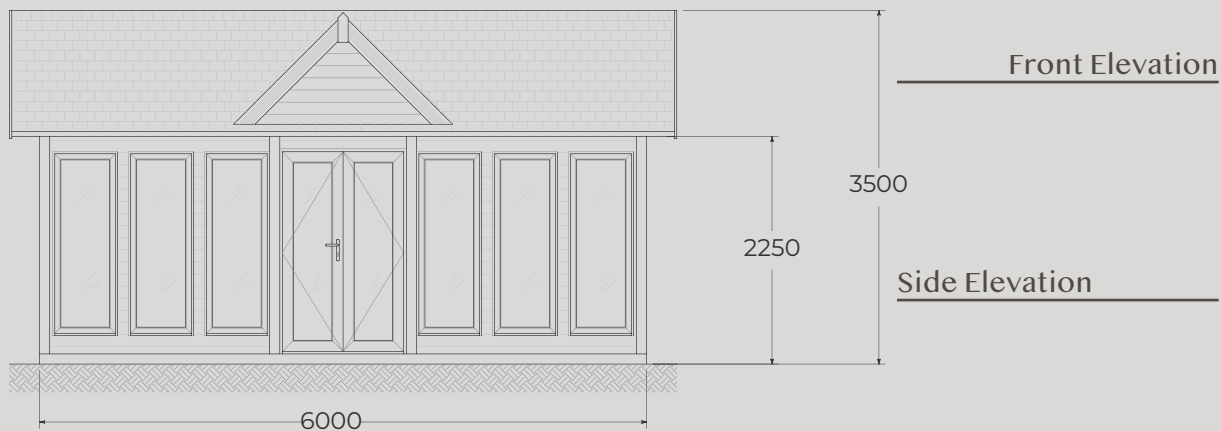

## Heritage 6.0XL (Pitched Roof)

The Heritage 6.0XL at 6 meters x 4.5 meters provides expansive extra living space in your garden. All our Heritage buildings are available in a range of external colours to suit your garden. Take advantage of unique upgrade features including a charming mezzanine store deck. Its pitched roof offers additional internal ceiling height and extra light, thanks to its integrated skylight.

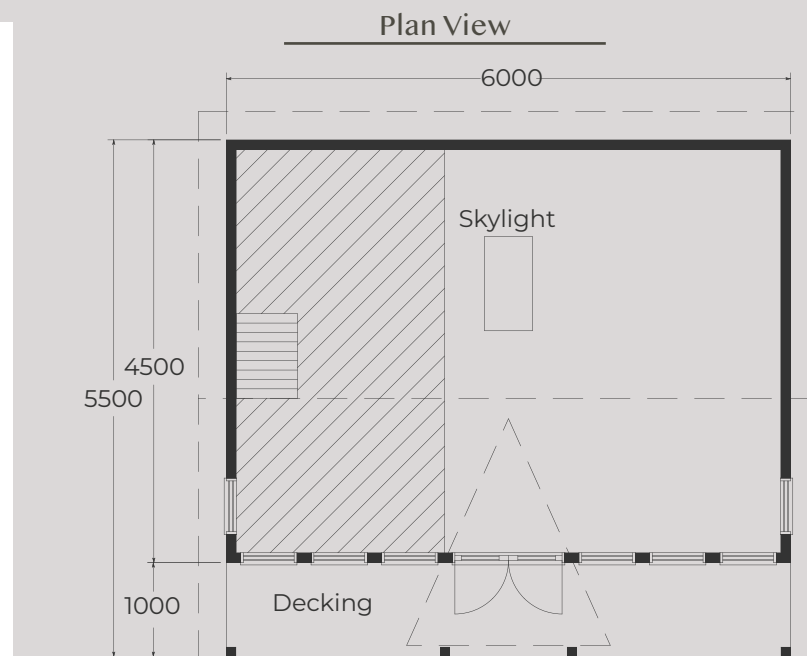

### Optional Extras

Mezzanine store deck: **£800**

Veranda (1m): **£1,100**

SPC flooring (Stone Plastic Composite) upgrade: **£2,025**

Cedar tile roof upgrade: **£6,210**

Base and mains electrical connection not included

**£43,430** incl VAT  
Installation included  
(England & Wales)

# Detailed Specs, Inclusions & Options

Feature	Specs/Package Inclusions & Options
Veranda	Available as an upgrade for all models
Roof	Flat Roof or Pitched Roof with Asphalt Tiles (Black or Brown Tiles, or Cedar Upgrade)
Dormer Roof Feature	Standard for all Pitched Roof Models
Mezzanine Store Deck	Available for the following pitched roof models: 6m x 3m, 6m x 4m, 6m x 4.5m
External Cladding	Weatherboard, painted with Sadolin Superdec
Wall/Ceiling Insulation	Rockwool (75mm / 100mm)
Floor Insulation	Thinsulate Foil
Flooring	Ply finish as standard (stone, plastic, composite SPC - finished flooring upgrade available)
Doors	White UPVC as standard or upgrade to Anthracite grey premium aluminium with triple glazing.
Windows	White UPVC as standard or upgrade to Anthracite grey premium aluminium with triple glazing.
Velux Opening Skylight	Standard For All Pitched Roof Models
Internal Wall Finish	White colour-washed Pine TGV
Skirting Board/Architraves	White colour-washed Timber
Internal Lights	Tracks of 3 x spotlights (1 or 2 tracks depending on building size) with downlighters and dimmer
Electrical Sockets	4 x Double Sockets (surface-mounted)
Heating	1 x Electric Wall Heater
Fuse Box	1 x Internal Fuse Box (all internal wiring included and terminated at fuse box)
Warranty	10-year Structural Guarantee / 1-year Accessories Guarantee

Base and mains electrical connection can be quoted separately

# Pricing Overview

## (Flat Roof)



3m x 3m



4.5m x 4m



6m x 3m

WIDTH (M)

	2.5	3	3.5	4	4.5	5	5.5	6	6.5	
DEPTH (M)	2.5	N/A	£ 18,030	£ 19,120	£ 20,210	£ 21,300	£ 22,400	£ 23,490	£ 24,580	£ 25,670
3	£ 18,030	£ 19,230	£ 20,430	£ 22,400	£ 25,020	£ 25,130	£ 26,220	£ 27,200	£ 28,410	
3.5	£ 19,120	£ 20,430	£ 22,940	£ 24,580	£ 25,670	£ 26,550	£ 27,970	£ 30,040	£ 31,140	
4	£ 20,210	£ 22,400	£ 24,580	£ 25,780	£ 26,380	£ 28,730	£ 30,590	£ 32,120	£ 34,410	
4.5	£ 21,300	£ 25,020	£ 25,670	£ 26,380	£ 28,410	£ 30,590	£ 32,780	£ 36,220	£ 38,510	
5	£ 22,400	£ 25,130	£ 26,550	£ 28,410	£ 31,680	£ 33,870	£ 36,380	£ 39,330	N/A	

\*Planning permission advice available

\*Non-standard sizes also available

# Pricing Overview

## (Pitched Roof)



3m x 3m



4.5m x 4m



6m x 3m



6m x 4m



6m x 4.5m

		WIDTH (M)								
		2.5	3	3.5	4	4.5	5	5.5	6	6.5
DEPTH (M)	2.5	N/A	£ 21,850	£ 24,040	£ 27,310	£ 30,590	£ 32,780	£ 33,870	£ 36,600	£ 38,240
	3	£ 21,850	£ 23,980	£ 26,770	£ 29,500	£ 32,230	£ 34,960	£ 36,600	£ 38,400	£ 41,730
	3.5	£ 24,040	£ 26,770	£ 30,040	£ 32,780	£ 35,180	£ 37,150	£ 38,240	£ 39,330	£ 42,390
	4	£ 27,310	£ 29,500	£ 32,780	£ 35,510	£ 37,860	£ 38,780	£ 39,880	£ 40,910	£ 43,150
	4.5	£ 30,590	£ 32,230	£ 35,180	£ 37,860	£ 38,890	£ 40,420	£ 41,520	£ 43,430	£ 44,790
	5	£ 32,780	£ 34,960	£ 37,150	£ 38,780	£ 40,420	£ 41,730	£ 43,150	£ 44,250	N/A

\*Planning permission advice available

\*Non-standard sizes also available

# Pricing Overview

## (Upgrade Price)

### Flat Roof

Building Front	Veranda	Flooring
3.0m (2 front windows)	£ 650	£ 75/m <sup>2</sup>
3.5m (2 front windows)	£ 700	£ 75/m <sup>2</sup>
4.0m (2 front windows)	£ 750	£ 75/m <sup>2</sup>
4.5m (4 front windows)	£ 800	£ 75/m <sup>2</sup>
5.0m (4 front windows)	£ 850	£ 75/m <sup>2</sup>
5.5m (4 front windows)	£ 950	£ 75/m <sup>2</sup>
6.0m (6 front windows)	£ 1,100	£ 75/m <sup>2</sup>
6.5m (6 front windows)	£ 1,200	£ 75/m <sup>2</sup>

### Pitched Roof

Building Front	Store Deck	Veranda	Flooring
3.0m (2 front windows)	N/A	£ 650	£ 75/m <sup>2</sup>
3.5m (2 front windows)	N/A	£ 700	£ 75/m <sup>2</sup>
4.0m (2 front windows)	N/A	£ 750	£ 75/m <sup>2</sup>
4.5m (4 front windows)	N/A	£ 800	£ 75/m <sup>2</sup>
5.0m (4 front windows)	£ 600	£ 850	£ 75/m <sup>2</sup>
5.5m (4 front windows)	£ 700	£ 950	£ 75/m <sup>2</sup>
6.0m (6 front windows)	£ 800	£ 1,100	£ 75/m <sup>2</sup>
6.5m (6 front windows)	£ 800	£ 1,200	£ 75/m <sup>2</sup>

### Cedar Pitched Roof

		WIDTH (M)								
		2.5	3	3.5	4	4.5	5	5.5	6	6.5
DEPTH (M)	2.5	N/A	£ 1,730	£ 2,010	£ 2,300	£ 2,590	£ 2,880	£ 3,160	£ 3,450	£ 3,740
	3	£ 1,730	£ 2,070	£ 2,420	£ 2,760	£ 3,110	£ 3,450	£ 3,800	£ 4,140	£ 4,490
	3.5	£ 2,010	£ 2,420	£ 2,820	£ 3,220	£ 3,620	£ 4,030	£ 4,430	£ 4,830	£ 5,230
	4	£ 2,300	£ 2,760	£ 3,220	£ 3,680	£ 4,140	£ 4,600	£ 5,060	£ 5,520	£ 5,980
	4.5	£ 2,590	£ 3,110	£ 3,620	£ 4,140	£ 4,660	£ 5,180	£ 5,690	£ 6,210	£ 6,730
	5	£ 2,880	£ 3,450	£ 4,030	£ 4,600	£ 5,180	£ 5,750	£ 6,330	£ 6,900	N/A

# Smart Air Conditioner

This wall-mounted all-in-one model, finished in white, is a great performer for year-round use as it works as a powerful air conditioner in the summer and a cost-effective heater in the winter. It functions as a dehumidifier too, which is great for keeping damp and moisture at bay. Customers can choose this option instead of the standard electric panel heater.

## 10,000 BTU

- 10,000 BTU cooling and heating for large rooms up to 30 sqm (320 sqft)
- 3-in-1: Cool | Heat | Dehumidify
- All-in-one - No outdoor unit is required, this AC is neatly vented through the wall
- Slimline Design - Thinnest air conditioner on the market at just 20cm deep
- Smart - Control from your phone or home assistant. Smart scheduling saves energy
- Quietest all-in-one air conditioner - 58dB
- 24-hr timer to pre-cool rooms and turn off during the night. Scheduling saves money

## 12,000 BTU

- 12,000 BTU cooling and heating for large rooms up to 35 sqm (377 sqft)
- 3-in-1: Cool | Heat | Dehumidify
- All-in-one - No outdoor unit is required, this AC is neatly vented through the wall
- Slimline Design - Thinnest air conditioner on the market at just 20cm deep
- Smart - Control from your phone or home assistant. Smart scheduling saves energy
- Quietest all-in-one air conditioner - 61dB
- 24-hr timer to pre-cool rooms and turn off during the night. Scheduling saves money



Great for areas up to 35m<sup>2</sup>



Cooling & Heating



Alexa and Google Home enabled



24 hour timer



# Triple Glazing

Triple glazing is the ultimate choice and superior to double glazing as it improves energy efficiency, comfort and noise reduction. Here's a clear breakdown:



## 1. Better insulation (U-value)

Triple glazing has three panes of glass and two insulating air/gas layers, while double glazing has only two panes and one layer. This means triple glazing:

- Keeps heat inside during winter
- Keeps heat out during summer
- Reduces heating/cooling costs

## 2. Less heat loss near windows

Triple glazing reduces the “cold surface” effect.

Benefits:

- Fewer cold drafts near windows
- More consistent room temperature
- Windows feel warmer to the touch

## 3. Better noise reduction

The extra glass layer + extra cavity gives:

- Lower outside noise
- Better performance for busy roads or cities

## 4. Less condensation

Inside surface is warmer, so:

- Less moisture forms on glass
- Reduced risk of mould or damp



CROWN PAVILIONS

# Smokeless BBQ Collection

A refined, smoke-free way to cook and entertain, designed to sit seamlessly within our pavilions. Available as an option across all garden rooms, the Smokeless BBQ features an integrated extraction system that reduces smoke at source, creating a clean and comfortable space for cooking and dining together, whatever the season.

Designed to integrate effortlessly within your pavilion, with built-in grease management for a cleaner cooking experience and comfortable year-round use.



## Single Grill

Dimensions:  
Oval (1300 x 1600 mm)  
Rectangular (1448 x 868 mm)

*A more compact option, suited to everyday use.*



## Double Grill

Dimensions:  
Rectangular (2300 x 1000 mm)  
Oval (1600 x 2000 mm)

*A larger format, ideal for hosting and entertaining.*

Smokeless BBQ is available as an option on all garden rooms. Contact our team for full specifications.







CROWN PAVILIONS

## Our Showrooms

**Alton Garden Centre (Essex)**

Arterial Road (A127), Wickford, Essex SS12 9JG

**Van Hage Garden Centre (Hertfordshire)**

Pepper Hill, Great Amwell, Hertfordshire SG12 9RP

**Chessington Garden Centre  
(Kingston Upon Thames)**

Leatherhead Rd, Chessington KT9 2NG

**Frosts Garden Centre (Buckinghamshire)**

Newport Rd, Woburn Sands, Milton Keynes MK17 8UE

**Longacres Garden Centre (Surrey)**

London Road, Bagshot, Surrey GU19 5JB

**Bridgemere Garden Centre**

Bridgemere, Nantwich, Cheshire, CW5 7SN

Call : 01491-612-820

[sales@crownpavilions.com](mailto:sales@crownpavilions.com)

[www.crownpavilions.com](http://www.crownpavilions.com)

*The marque of excellence*